

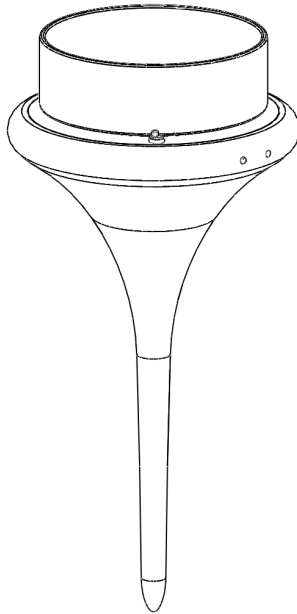

Fire Wonderland

glamm®
fire



Flut

Dimensions H 720mm x Ø404 mm

Weight – 5,5 kg

Supplied Material

- «Flut» model
- Burner
- High temperature glass.

Option : vertical support with 3 sets of fixing

- For wood ground (4 screws).
- For concrete ground (4 screws, washers and metal bushings);
- For grass (4 screws in stainless).

Option: positioning in swimming pools include:

- Two rear hubs pre – equipped with thread;
- A set of two rear hubs for floor in wood / concrete floor;
- A set of two rear hubs supports for wood/concrete floor.

Needed tools

- Drill;
- Screwdriver.

Option : installation procedure for vertical support

1- Put the support "E" in the local chosen. According to the type of floor choose the appropriate fixing;

2a1 – For a rough ground, fix the " F" and use the marks for the holes;

2a2 – Drill the ground with the help of a drill machine (6 mm drill) and then introduced the metal bushings;

2a3 – Screw the support "E" without forgetting the washers;

2b1 – For grass put the anchors using the "F" holes;

3 – Set the tube "D" to support "E". This one must be positioned in vertical;

4 – Fit the model " C" in support " D";

5 – Put the burner " B " in model " C".

6—Finally fit the round glass "A" in the fireplace.

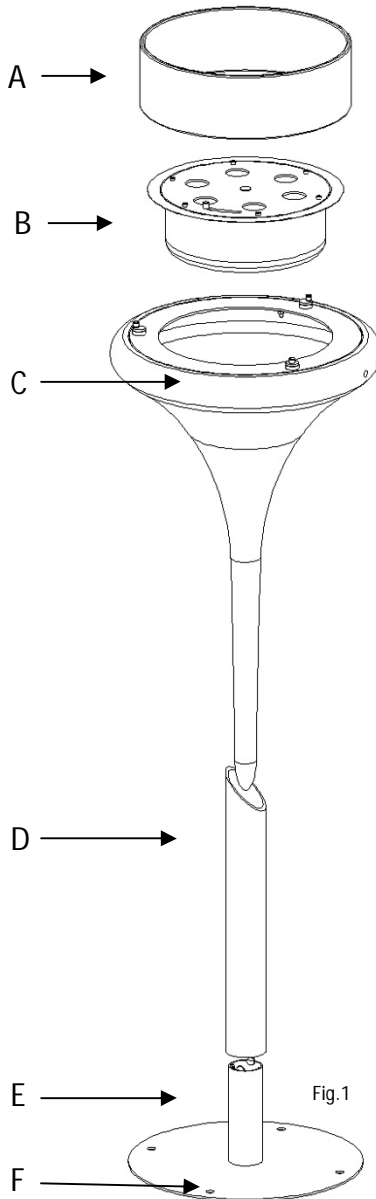

Option: Swimming pools system

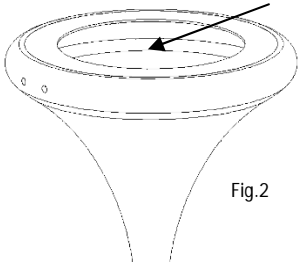

Fig.2

Install the burner in the floating fireplace.

Then using this type of node to connect the two rear hubs.

Fig.3

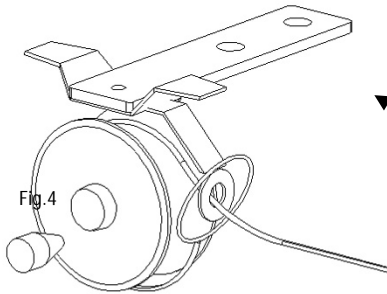
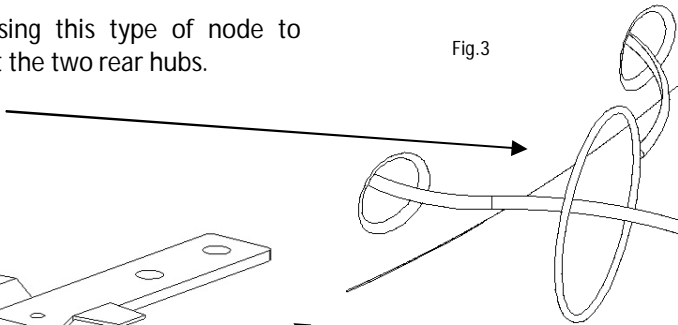

Fig.4

System for setting in grass ;

System for setting in rough ground;

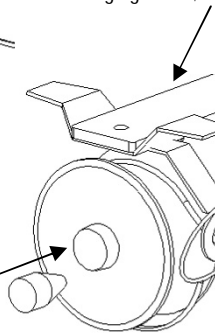

Fig.5

Button to regulate the power

Unroll the two rear hub and then fix in the both sides of the pool in the axis chosen (Roll/Unroll the Button power.)

Then fixing the systems on floor (according the most suitable material);

- In the grass you must stick;
- In ground like woods or concrete you must use the screws provided;

Put the fireplace in the pool and rewind the rear hubs to immobilize the fireplace in the middle of the pool. This adjustment also is used to fill the fireplace.

Fig.6

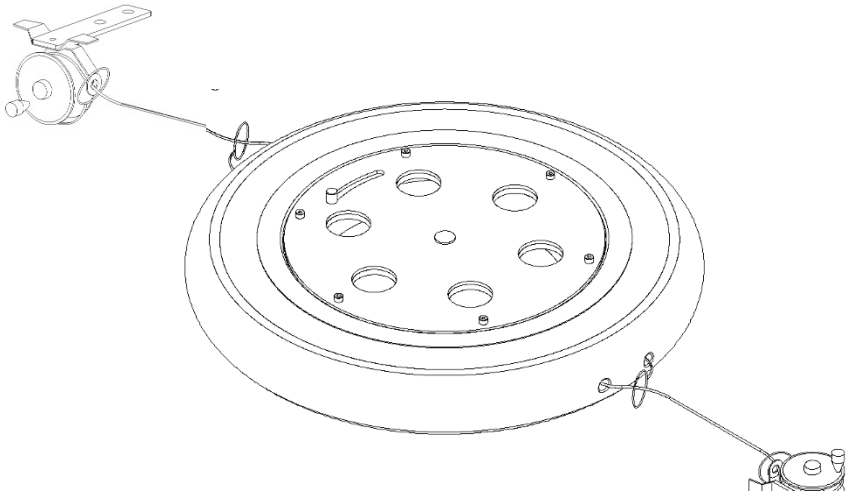

(Example of positioning in the pool)

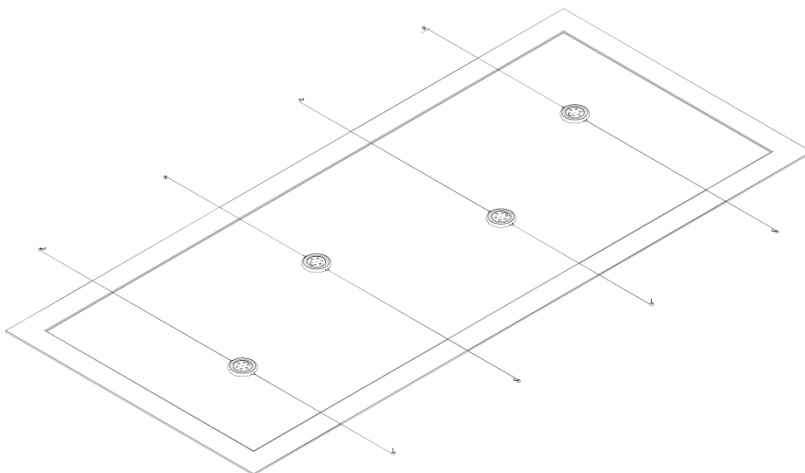

After – sale service

In case of any anomaly, please contact the specialized technician.

Warranty

2 years against manufacture defects (the warranty do not include glasses).

Equipment	warranty beneficiary
Version	Address
Controller	Telephone Availability date LocalDate Signature
Series number of warranty	
Distributor code	
Name and address of the distributor	

GlammFire fireplaces are manufactured under the strict Standard of the world recognized ISO 9001:2008 Quality Assurance Certificate.

GlammFire products are designed with superior components and materials, assembled by trained craftsmen who take great pride in their work.

Once assembled the complete fireplace is thoroughly inspected by a qualified technician before packaging to ensure that you, the customer, receive the quality product that you expect from GlammFire.



glamm[®]
fire

Recuperadores Pachinha Lda.
Zona Industrial da Lagoa, Lote G1
4950-850 CORTES - MONÇÃO PORTUGAL
Tel(+351) 251 654 800
Fax(+351) 251 654 801
info@glammfire.com
www.glammfire.com

PJ00015-X-XX



certificação
acreditada
IFAC



certificação
acreditada
IFAC